

MANUXELECT



PARTNER FOR LIFE

The examination and treatment couch par excellence for a small treatment room and a limited budget. Because of the scissors mechanism the ManuXelect is raised fully vertically. Consequently the ManuXelect takes up only 1.4 m²! The easily adjustable sections make this couch easy to operate and stable throughout. A cost-effective variant for someone who has little space available. The ManuXelect treatment couch comes in two 2-section models and in a 3-section variant.



ManuXelect



- Electrical height adjustment from 48 to 105 cm
- Section adjustment with gas springs
- Ergonomic handles for operation with one hand
- Scissors movement saves space. The couch travels up and down linearly
- Padded sections with soft edges
- The nose hole (with optional plug) ensures patient comfort even when lying face down



ENRAF-NONIUS B.V.
Vareseweg 127
3047 AT Rotterdam
The Netherlands
T: +31-(0)10 - 203 06 00
E: info@enraf-nonius.nl
www.enraf-nonius.com

MANUXELECT

MANUXELECT



PARTNER FOR LIFE

MANUXELECT, 3-SECTION

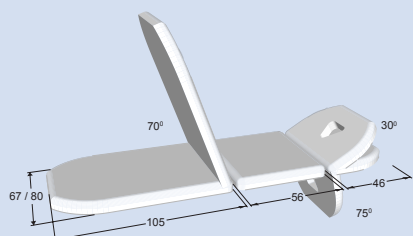

MANUXELECT, 2-SECTION, HEAD-SECTION

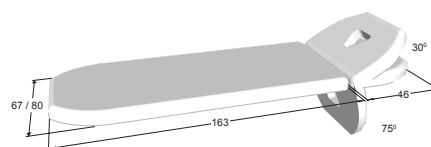

MANUXELECT, 2-SECTION, BACK SECTION

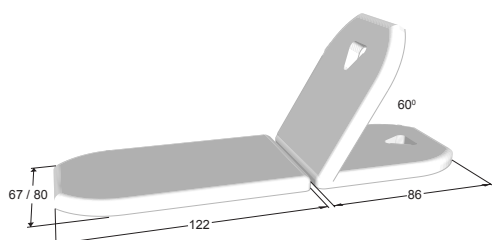

MANUXELECT TRACTION

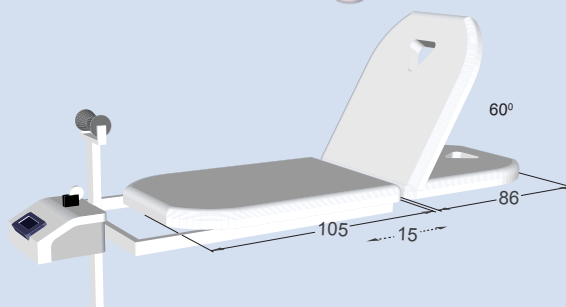

MANUXELECT

MANUXELECT

TECHNICAL SPECIFICATIONS

Size tabletop (lxw):	207 - 209 x 67 cm (optional 80 cm width)
Height adjustment:	approximately 48,5-105,5 cm
Lifting time (min.-max.):	approximately 35 sec.
Lifting capacity:	150 kg (optional 250 kg)
Power supply:	120/230VAC 50/60 Hz
Current consumption:	1.5 A-350W max. (light) or 2.0 A-470W max. (heavy)
Colour code frame:	grey = RAL 7035
Foam density:	38 Kg/m ³

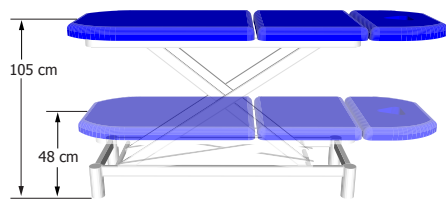

ManuXelect | | | |



EXECUTIVE



012⁽¹⁾
black

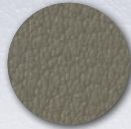

213
grey

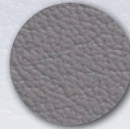

199⁽¹⁾
lavender



204
sirius blue

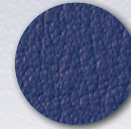

169⁽¹⁾
cornflower
blue

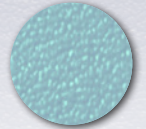

170⁽¹⁾
baby blue

Note! Please order together with the couch because of modification of the couch



FRAME COLOURS



RaI 7035
grey

UPHOLSTERY OPTION	
Section Width	4 cm thick
67 cm	S
80 cm ^{(1) (2)}	O

S = Standard
O = Optional

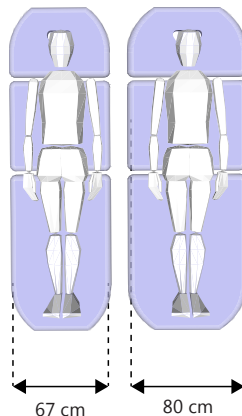

A matching Enraf-Nonius couch for every interior. As in other practices, a pleasant ambience is important in physiotherapy practices. Clients must feel comfortable in the room where they are being treated. As each practice is furnished differently and has its own colour scheme, we regard it as important for the treatment couches to fit in with your look and feel. That is why we can manufacture our treatment couches in several frame and upholstery colours.

Our imitation leather upholstery contains no phthalates and is flame retardant – a unique combination that makes this material suitable for medical use!

Note! Please order together with the couch because of modification of the couch
(1) = Not available for traction version
(2) = Only available in colours 204, 213 and 199



OPTIONS MANUXELECT

HEIGHT ADJUSTMENT

- A. All-around (optional)
- B. Footswitch (optional)
- C. Handswitch (optional)



A



B



C

LIFTING CAPACITY

- A. Electric - max. 150 kg (standard)
- B. Electric - max 250 kg (optional)



A



B

OPTIONAL FEATURES

- A. Wheel raising set
- B. 1550801 Safety switch
- C. 1550804 Fold down side support (set of 2) ⁽¹⁾



A

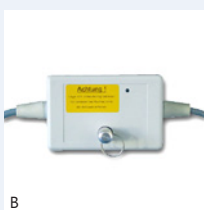

B

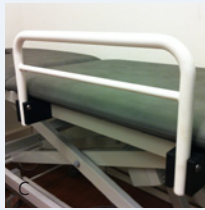

NOTE: Please order options together with the couch because of modification of the couch during production.

⁽¹⁾ = Not suitable with 80 cm wide couches, and not suitable for traction version.

PAPER ROLL HOLDER AND PAPER ROLLS ⁽¹⁾

1550800	Paper roll holder for ManuXelect, for 40, 50 & 60 cm rolls, mounted under foot-section
3445280	Paper roll holder, stand-alone model
3445284	Paper roll, width 40 cm, roll-length 150 m, per 5 rolls
3445278	Paper roll, width 50 cm, roll-length 150 m, per 5 rolls
3445279	Paper roll, width 60 cm, roll-length 150 m, per 5 rolls



FIXATION ACCESSORIES ⁽¹⁾

1550815	Fixation horn, black ⁽²⁾ (set of 2)
1550806	Fixation rail for fixation horn shoulder, armpit (and for gynaecological set)
1550807	Fixation rail for fixation horn armpit (or for gynaecological set)
1550808	Fixation rail for fixation horn shoulder.



FIXATION STRAPS

3445023	Fixation strap with velcro fastener 120 cm
3445014	Fixation strap with velcro fastener 160 cm
3445015	Fixation strap with velcro fastener 240 cm
3445475	Fixation strap with safety lock 250 cm
3445474	Fixation strap with safety lock 350 cm



⁽¹⁾ = Not suitable for traction version or 80 cm wide couches.
⁽²⁾ = Requires 1550806, 1550807 or 1550808.

ACCESSORIES MANUXELECT

STOOLS (AVAILABLE IN ALL COLOURS SHOWN BELOW)

3xxx010	Stool, height adjustable 40-53 cm
3xxx011	Stool, mobile, height adjustable 59-85 cm
3xxx012	Stool, mobile, provided with footrest, height adjustable 59-85 cm
3xxx013	Stool, mobile, anatomic seat, height adjustable 43-56 cm
3xxx020	Stool, mobile, saddle seat, height adjustable 59-85 cm



ROLLS AND CUSHIONS (AVAILABLE IN ALL COLOURS SHOWN BELOW)

3xxx002	Halfroll, flat bottom, small, especially for the ankle	28x9x11 cm
3xxx003	Halfroll, flat bottom, large	56x16x18 cm
3xxx023	Massage roll	50x Ø15 cm
3xxx004	Neck cushion, hourglass type	30x15 cm
3xxx005	Massage cushion	30x28x8 cm
3xxx015	Wedge shaped cushion	50x30x15 cm
1550813	Plug for nosehole, triangular shaped (only available in black)	16,5 x 21 cm
3445297	Wedge shaped, Kaltenborn, rubber model (only available in black)	22,5 x 10,5 x 8,5
3446161	Support bag with sand 1,2 kg ⁽¹⁾	15x25 cm
3446162	Support bag with sand 2 kg ⁽¹⁾	18x27 cm
3446166	Support bag with sand 4 kg ⁽¹⁾	25x35 cm
3446167	Support bag with sand 7 kg ⁽¹⁾	30x45 cm

(1) = only available in grey



EXECUTIVE



ACCESSORIES MANUXELECT

COUCH COVERS

3445240	Couch cover, with a cutaway for the nose	blue
3445241	Couch cover, with a cutaway for the nose	bordeaux
3445242	Couch cover, with a cutaway for the nose	white
3445244	Couch cover, with a cutaway for the nose	jade
3445249	Couch cover, with a cutaway for the nose	dark grey
3445250	Couch cover, with a cutaway for the nose	royal blue
3445251	Couch cover, with a cutaway for the nose	camel
3445261	Couch cover, without a cutaway for the nose	blue
3445034	Couch cover, without a cutaway for the nose	bordeaux
3445267	Couch cover, without a cutaway for the nose	white
3445262	Couch cover, without a cutaway for the nose	jade
3445248	Couch cover, without a cutaway for the nose	dark grey
3445247	Couch cover, without a cutaway for the nose	royal blue
3445252	Couch cover, without a cutaway for the nose	camel
3445259	Elastic straps for couch cover with clip fittings at both ends, set of 3	

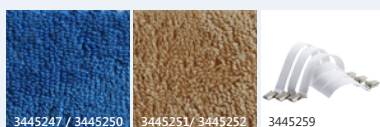
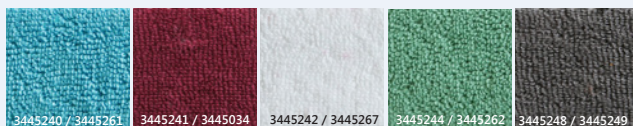

GYNAECOLOGY ACCESSORIES ⁽¹⁾

1550806	Fixation rail for gynaecological set (and for fixation horn shoulder, armpit)
1550807	Fixation rail for gynaecological set (and for fixation horn armpit)
1550810	Gynaecological Comfort set ⁽²⁾
1550805	Gynaecological set ⁽²⁾

⁽¹⁾ = Not suitable for traction version or 80 cm wide couches.

⁽²⁾ = Requires 1550806 or 1550807



1550810

1550805



1550806



1550807

MISCELLANEOUS

3446261	Set of 3 exercise stools, 50 x 38 x 32 cm, 40 x 32 x 21 cm and 30 x 22 x 14 cm
---------	--



3446261



MANUXELECT TRACTION



The traction version of the ManuXelect has a rolling section with a range of motion of 15 cm to perform traction therapy. This rolling section can also be locked in place for conventional use.

Your ManuXelect traction couch comes standard with a fixation rail on the head section and a traction frame for mounting the Eltrac 471 traction device.

The options for the height adjustment and the lifting capacity of the ManuXelect traction couch are the same as for the other ManuXelect versions.

Attention! The ManuXelect Traction is available only in the colours grey (colour number 213) and Sirius blue (colour number 204) and only with a section width of 67 cm.

TRACTION ACCESSORIES

3xxx014	Flexistool grey, with separate height adjustment for each leg, available in different colours
3445022	Pelvic belt for Manumed Traction
3445021	Thoracic belt for Manumed Traction
1471808	Saunders clinical traction device including mounting bracket for the Eltrac 471
1671901	Eltrac 471, unit for traction therapy

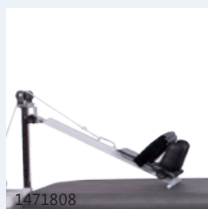

TECHNICAL SPECIFICATIONS

Size tabletop (lxw):	approximately 240 x 67 cm (incl. traction frame)
Movable leg section	15 cm
Lockable	yes

See brochure Eltrac 471 for more information.

